

SM202

Module 2 Entrées / 2 Sorties pour SM103E
2 Eingänge / 2 Ausgänge für SM103E
2 Inputs / 2 Outputs module for SM103E

- (FR) Notice d'instructions
- (DE) Bedienungsanleitung
- (GB) User instructions
- (IT) Istruzioni d'uso
- (NL) Gebruiksaanwijzing
- (ES) Instrucciones de uso
- (PT) Instruções de instalação

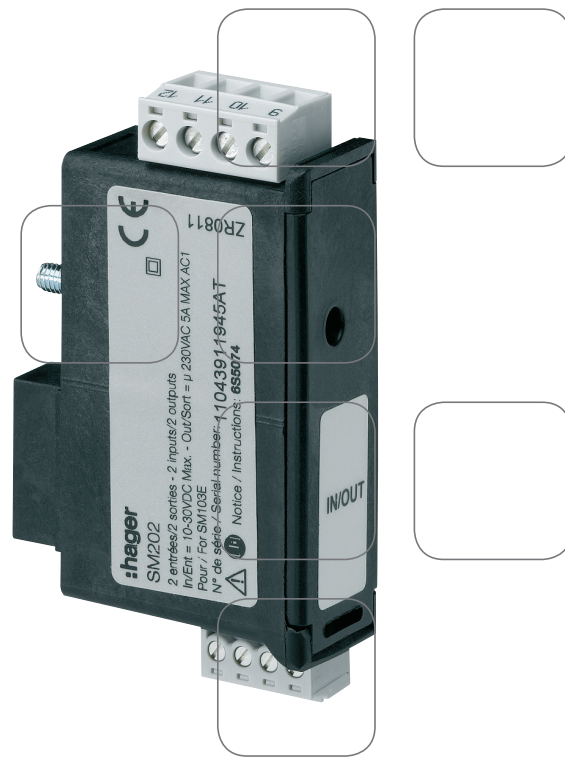

FR	Sommaire	
	Opérations préalables	4
	Présentation	6
	Installation	8
	Programmation.....	10
	Utilisation	22
	Caractéristiques techniques	23
	Lexique des abréviations	25

GB	Contents	
	Preliminary operations.....	4
	Presentation	6
	Installation	8
	Programming.....	10
	Operation	22
	Technical characteristics	23
	Glossary of abbreviations.....	27

DE	Inhaltsverzeichnis	
	Erste Schritte.....	4
	Produktdarstellung.....	6
	Installation	8
	Konfiguration.....	10
	Betrieb.....	22
	Technische Daten.....	23
	Glossar der Abkürzungen.....	26

IT	Sommario	
	Operazioni preliminari	4
	Presentazione.....	6
	Installazione.....	8
	Programmazione	10
	Utilizzo.....	22
	Caratteristiche tecniche	23
	Listo delle abbreviazioni.....	28

NL	Inhoud	
	Voorafgaande handelingen	5
	Presentatie	7
	Installering	8
	Programmering	10
	Gebruik.....	22
	Technische eigenschappen.....	24
	Lijst van afkortingen	29

PT	Índice	
	Operações preliminares	5
	Apresentação	7
	Instalação.....	8
	Programação.....	10
	Utilização.....	22
	Características técnicas.....	24
	Léxico das abreviaturas	31

ES	Índice	
	Operaciones previas	5
	Presentación	7
	Instalación	8
	Programación.....	10
	Utilización.....	22
	Características técnicas.....	24
	Léxico de las abreviaciones	30

FR

Au moment de la réception du colis contenant le module option, il est nécessaire de vérifier les points suivants :

- l'état de l'emballage,
- le produit n'a pas eu de dommage pendant le transport,
- la référence de l'appareil est conforme à votre commande,
- l'emballage comprend le produit,
- une notice d'utilisation.

DE

Nach Eingang der Lieferung, sollten sie folgendes überprüfen:

- Verpackungszustand,
- Transportschäden,
- Entspricht der Packungsinhalt Ihrer Bestellung,
- Die Verpackung enthält das Produkt,
- Ist eine Bedienungsanleitung vorhanden.

GB

Check the following points as soon as you receive the optional module package:

- the packing is in good condition,
- the product has not been damaged during transport,
- the product reference number conforms to your order,
- the package contains the product,
- the operating instructions.

IT

Al momento del ricevimento della scatola contenente il modulo opzione, è necessario verificare i seguenti punti:

- lo stato dell'imballo,
- la presenza di danneggiamenti o rotture dovuti al trasporto,
- se il numero di riferimento dell'apparechio è conforme a quello della richiesta,
- l'imballaggio comprende il prodotto,
- la presenza del libretto di istruzione originale.

Opérations préalables - Erste Schritte - Preliminary operations - Operazioni preliminari - Voorafgaande handelingen - Operaciones previas - Operacoes preliminares

NL

Bij ontvangst van de doos met de optiemodule moeten de volgende punten gecontroleerd worden:

- de staat van de verpakking,
- of het product geen schade heeft geleden tijdens het transport,
- of de referentie van het toestel overeenkomt met de bestelling,
- de verpakking bevat een product,
- of de gebruiksaanwijzing aanwezig is.

ES

Al recibir el paquete que contiene el módulo opcional, será necesario verificar los aspectos siguientes:

- estado del embalaje,
- que el producto no se haya dañado durante el transporte,
- que la referencia del Aparato esté conforme con su pedido,
- el embalaje incluye el producto,
- el manual de utilización.

PT

Na altura da recepção da encomenda do módulo opção, é necessário verificar os seguintes pontos:

- o estado da embalagem,
- se o produto não foi danificado durante o transporte,
- se a referência do Aparelho está acordo com a sua encomenda,
- dentro da embalagem encontrase realmente o produto,
- se existe um manual de utilização.

Présentation - Produktdarstellung - Presentation - Presentazione - Presentatie - Presentación - Apresentação

FR

Ce module option doit être connecté au produit **SM103E**. Pour la fonction de surveillance, programmation d'un seuil haut et bas, de l'hystérésis, de la temporisation et du mode de travail pour les I, In, U, V, $\Sigma P+$, $\Sigma P-$, $\Sigma Q+$, $\Sigma Q-$, ΣS , ΣPFL , ΣPFC , F, HOU_r, THD I, THD In, THD U, THD V, T°C1, T°C2, T°C3, T°C4 interne, PPR, QPR, SPR, Commande (CDE), Commande temporisée (CD-t).

Possibilité d'installer jusqu'à 3 modules donc 6 entrées / 6 sorties.

Ce module met à disposition la mémorisation des min/max instantanées pour les 3U, 3F, In, $\pm\Sigma P$, $\pm\Sigma Q$, ΣPF , F, thd 3U, thd 3I et thd In via la RS485.

DE

Diese Optionsmodul ist für den Anschluss an das Gerät **SM103E** bestimmt. Für die Überwachungsfunktion: Programmierung einer oberen und einer unteren Schwelle, der Hysterese, der Verzögerung und des Betriebsmodus für I, In, U, V, $\Sigma P+$, $\Sigma P-$, $\Sigma Q+$, $\Sigma Q-$, ΣS , ΣPFL , ΣPFC , F, HOU_r, THD I, THD In, THD U, THD V, T°C1, T°C2, T°C3, T°C4 intern, PPR, QPR, SPR, Antrieb (CDE), Zeitgesteuerte Steuerung (CD-t).

Es können bis zu 3 Module eingebaut werden, d. h. 6 Eingänge / 6 Ausgänge.

Dieses Modul ermöglicht die Speicherung der unmittelbaren Min.- und Max.-Werte für die 3U, 3F, In, $\pm\Sigma P$, $\pm\Sigma Q$, ΣPF , F, thd 3U, thd 3I und thd In über die RS 485.

GB

This optional module must be connected to the **SM103E** product. For the monitoring function, programming of an upper and lower threshold, of the hysteresis, of the time delay and of the run mode for I, In, U, V, $\Sigma P+$, $\Sigma P-$, $\Sigma Q+$, $\Sigma Q-$, ΣS , ΣPFL , ΣPFC , F, HOU_r, THD I, THD In, THD U, THD V, T°C1, T°C2, T°C3, T°C4 internal, PPR, QPR, SPR, Control (CDE), Timed control (CD-t). Possibility of installing up to 3 modules, that is 6 inputs / 6 outputs.

This module provides instant storage of min/max values for the 3U, 3F, In, $\pm\Sigma P$, $\pm\Sigma Q$, ΣPF , F, thd 3U, thd 3I and thd In via the RS 485.

IT

Questo modulo opzione deve essere collegato al prodotto **SM103E**. Per la funzione di monitoraggio, programmazione di una soglia alta e bassa, dell'isteresi, della temporizzazione e del modo di lavoro per i I, In, U, V, $\Sigma P+$, $\Sigma P-$, $\Sigma Q+$, $\Sigma Q-$, ΣS , ΣPFL , ΣPFC , F, HOU_r, THD I, THD In, THD U, THD V, T°C1, T°C2, T°C3, T°C4 interna, PPR, QPR, SPR, Comando (CDE), Comando temporizzato (CD-t).

Possibilità di installare fino a 3 moduli, quindi 6 ingressi / 6 uscite.

Questo modulo mette a disposizione la memorizzazione delle min/max istantanee per le 3U, 3F, In, $\pm\Sigma P$, $\pm\Sigma Q$, ΣPF , F, thd 3U, thd 3I e thd In tramite la RS 485.

Présentation - Produktdarstellung - Presentation - Presentazione - Presentatie - Presentación - Apresentação

(NL)

Deze optiemodule moet worden aangesloten de product **SM103E**. Voor de bewakingsfunctie, programmering van een hoge en lage drempel, van de hysteresis, de wachttijd en de werkwijze voor de I, In, U, V, $\Sigma P+$, $\Sigma P-$, $\Sigma Q+$, $\Sigma Q-$, ΣS , ΣPFL , ΣPFC , F, HOU_r, THD I, THD In, THD U, THD V, T°C1, T°C2, T°C3, T°C4 interne, PPR, QPR, SPR, Commando (CDE), Tijdgeschakeld commando (CD-t).

De mogelijkheid om tot 3 modules te installeren, dus 6 ingangen / 6 uitgangen.

Dit module stelt memorisatie ter beschikking van de ogenblikkelijke min/max voor de 3U, 3F, In, $\pm\Sigma P$, $\pm\Sigma Q$, ΣPF , F, thd 3U, thd 3I en thd In via de RS 485.

(ES)

Este módulo opcional se debe conectar a el producto **SM103E**. Para la función de vigilancia, de la programación de un umbral superior e inferior, de la histéresis, de la temporización y del modo de trabajo para los I, In, U, V, $\Sigma P+$, $\Sigma P-$, $\Sigma Q+$, $\Sigma Q-$, ΣS , ΣPFL , ΣPFC , F, HOU_r, THD I, THD In, THD U, THD V, T°C1, T°C2, T°C3, T°C4 interna, PPR, QPR, SPR, Control (CDE), Control con temporización (CD-t).

Existe la posibilidad de instalar hasta 3 módulos que corresponden a 6 entradas/6 salidas.

A partir de este módulo se puede memorizar los mínimos / máximos instantáneos para los 3U, 3F, In, $\pm\Sigma P$, $\pm\Sigma Q$, ΣPF , F, thd 3U, thd 3I y thd In vía la RS 485.

(PT)

Este módulo opção deve ser ligado do produto **SM103E**. Para a função de vigilância, programação de um limite alto e baixo, da histeresia, da temporização e do modo de trabalho para os I, In, U, V, $\Sigma P+$, $\Sigma P-$, $\Sigma Q+$, $\Sigma Q-$, ΣS , ΣPFL , ΣPFC , F, HOU_r, THD I, THD In, THD U, THD V, T°C1, T°C2, T°C3, T°C4 interna, PPR, QPR, SPR, Comando (CDE), Comando temporizado (CD-t).

Possibilidade de instalar até 3 módulos portanto 6 entradas / 6 saídas.

Este módulo coloca à disposição, a memorização dos mínimos / máximos instantâneos para os 3U, 3F, In, $\pm\Sigma P$, $\pm\Sigma Q$, ΣPF , F, thd 3U, thd 3I e thd In via a RS 485.

Installation - Installation - Installation - Installazione -
Instalering - Instalación - Instalação

FR Raccordement

DE Anschluß

GB Connection

IT Collegamento

NL Aansluiting

ES Parte trasera

PT Ligação



Le produit SM103E doit être hors tension.
Das Gerät SM103E muß spannungsfrei sein.
The SM103E product must be disconnected.
Il prodotto SM103E deve essere fuori tensione.
De product SM103E moet zonder spanning staan.
El producto SM103E deberá estar desconectado.
O produto SM103E deve ficar desligado.

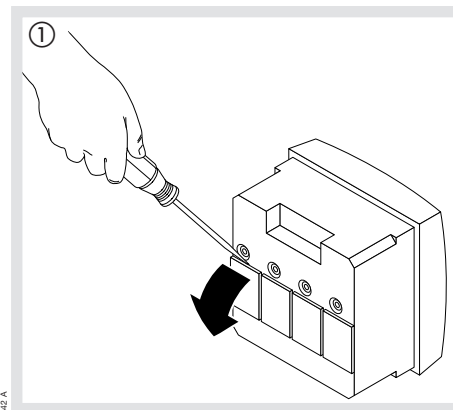

342 A

2 Fixer le module - Das Modul einschieben -
Fix the module - Fissare il modulo - Bevestig
de module - Fije el módulo - Fixe o módulo

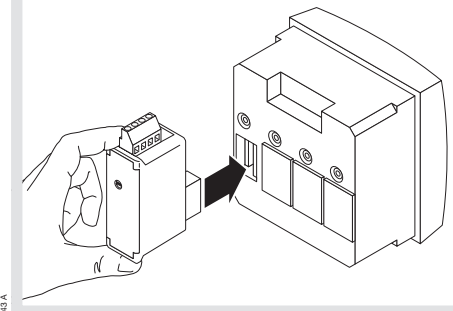

343 A

Installation - Installation - Installation - Installazione -
 Installering - Instalación - Instalação

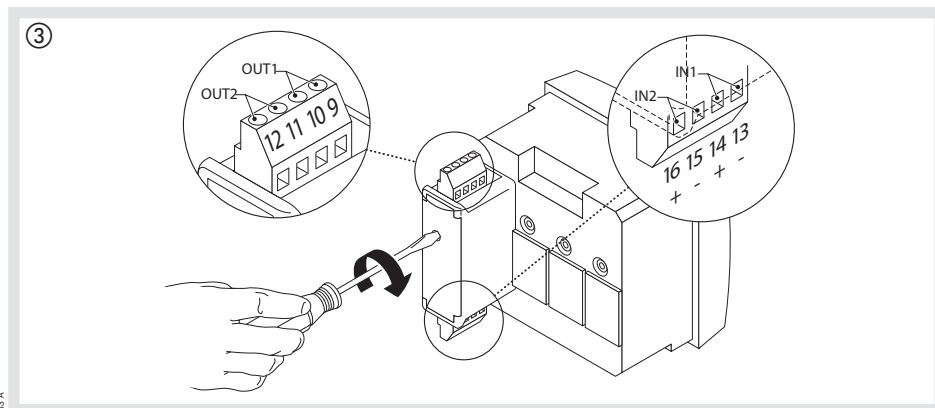

433 A

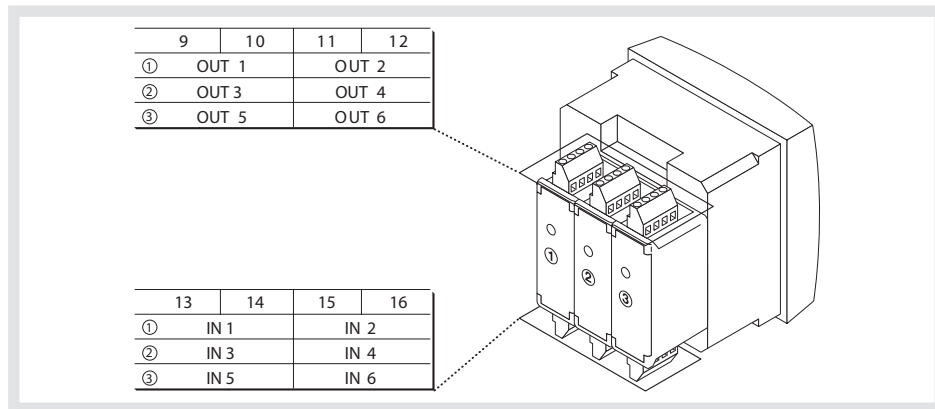

- ④ Raccorder le bornier en respectant les indications. Remettre sous tension.
Die Klemmleiste entsprechend der Hinweise anschliessen. Die Versorgungsspannung wieder einschalten.
Follow indications when connecting the terminal. Switch on voltage supply.
Raccordare i morsetti rispettando le indicazioni. Alimentare il prodotto SM103E.
De klemmenstrook aansluiten zoals aangegeven. Terug spanning geven.
Conexionar respetando las indicaciones. Poner en tensión.
Ligar o terminal de bornes respeitando as indicações. Colocar sob tensão novamente.

- ⑤ Lors de l'installation de 2 ou 3 modules (maximum) les modules doivent être installés comme indiqué ci-dessus.
Beim Einbau von 2 oder max. 3 Modulen, bitte die o. g. Hinweise beachten.
When installing 2 or 3 modules (maximum), the modules should be installed as indicated above.
Quando si installano due o tre moduli uguali tra loro, questi devono essere montati come indicato di seguito
Bij de installatie van 2 of 3 modules (maximum) dienen deze modules te worden geïnstalleerd zoals hierboven is aangeduid.
Durante la instalación de 2 ó 3 módulos (máximo), los módulos deben ser instalados como se indicada a continuación.
Durante a instalação de 2 ou 3 módulos (máximo), os módulos devem ser instalados como abaixo indicado.

- Ⓡ Menu programmation
- Ⓝ Programmierungsmenü
- Ⓢ Programming menu
- Ⓜ Menu programmazione
- Ⓝ Programmatie menu
- Ⓝ Programación menú
- Ⓝ Programação menu

Vorheriges Menü - Previous menu - Menu precedente -
 Menu voorgaand - Menú anterior - Menu precedente

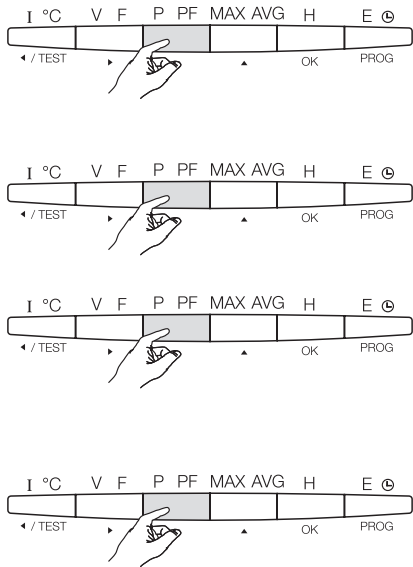

Menu précédent



p. 13



p. 14
p. 15



p. 16
p. 17



p. 18

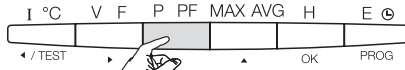
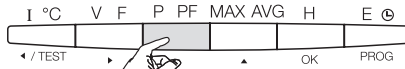
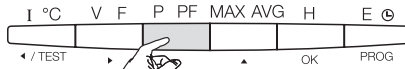
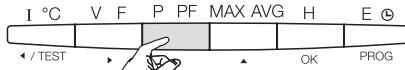

p. 19



p. 20

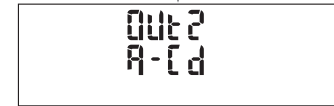

p. 21



p. 21

Menu suivant

*Folgendes Menü - Following menu - Menu seguire -
Menu volgend - Menú siguiente - Menu seguir*

Programmation - Konfiguration - Programming - Programmazione - Programmering- Programación - Programação

FR Type de la sortie relais n° 1
 Exemple : TYPE = 1

DE Art des Relaisausgangs Nr. 1
 Beispiel: TYPE = 1

GB N°1 analog relay type
 Example : TYPE = 1

IT Tipo di uscita analogica n° 1
 Esempio: TYPE = 1

NL Type van de analoge uitgang n° 1
 Voorbeeld: TYPE = 1

ES Tipo de la salida analógica n° 1
 Ejemplo: TYPE = 1

PT Tipo da saída analógica n° 1
 Exemplo: TYPE = 1

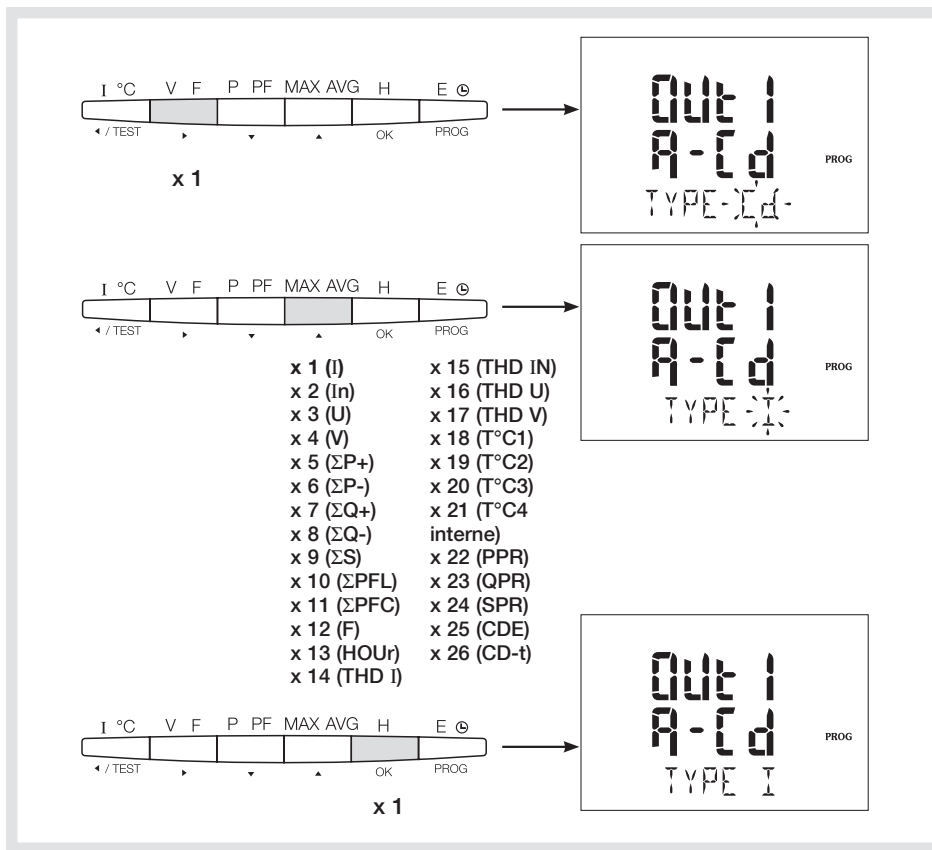

Programmation - Konfiguration - Programming - Programmazione -
 Programmering- Programación - Programação

- Ⓡ **FR** **Seuil haut de la sortie relais N° 1**
Exemple : Ht = 100 kA
- Ⓡ **DE** **Obere Schwelle des Relaisausgangs Nr. 1**
Beispiel: Ht = 100 kA
- Ⓡ **GB** **N° 1 output relay upper threshold**
Example : Ht = 100 kA
- Ⓡ **IT** **Soglia alta dell' uscita relè n° 1**
Esempio: Ht = 100 kA
- Ⓡ **NL** **Hoge drempel van de relaisuitgang n° 1**
Voorbeeld: Ht = 100 kA
- Ⓡ **ES** **Umbral superior de la salida relé n° 1**
Ejemplo: Ht = 100 kA
- Ⓡ **PT** **Limite alto da saída relés N° 1**
Exemplo: Ht = 100 kA

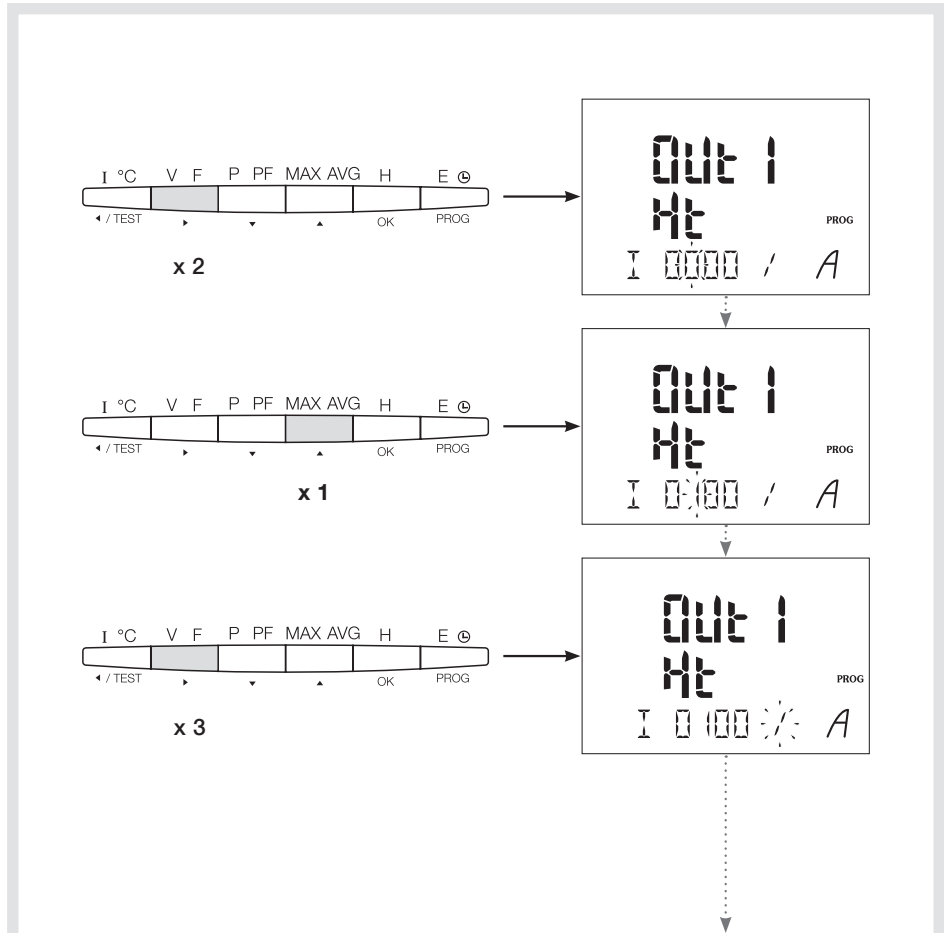

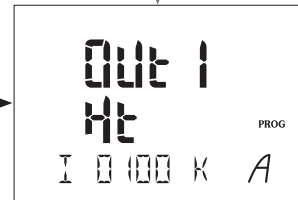
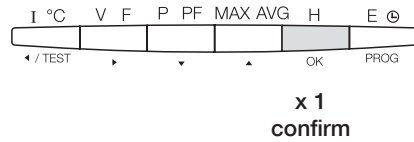
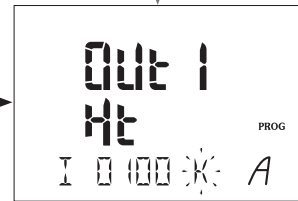
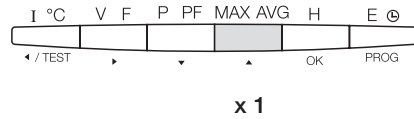

Programmation - Konfiguration - Programming - Programmazione -
 Programmering- Programación - Programação

- (FR) Seuil bas de la sortie relais N° 1**
 Exemple : Lt = 10 kA
- (DE) Untere Schwelle des Relaisausgangs Nr. 1**
 Beispiel: Lt = 10 kA
- (GB) N° 1 output relay lower threshold**
 Example : Lt = 10 kA
- (IT) Soglia bassa dell' uscita relè n° 1**
 Esempio: Lt = 10 kA
- (NL) Lage drempel van de relaisuitgang n° 1**
 Voorbeeld: Lt = 10 kA
- (ES) Umbral inferior de la salida relé n° 1**
 Ejemplo: Lt = 10 kA
- (PT) Limite baixo da saída relés N° 1**
 Exemplo: Lt = 10 kA

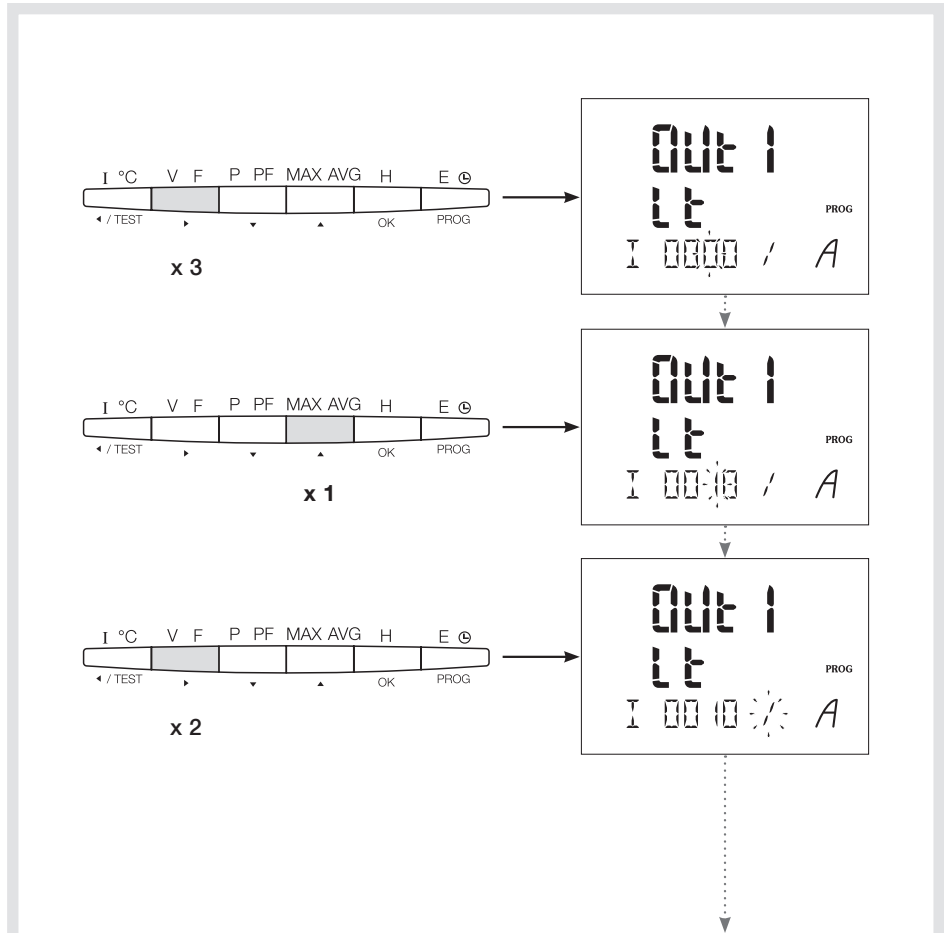

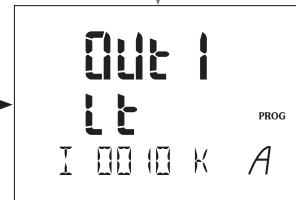
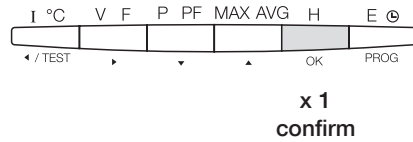
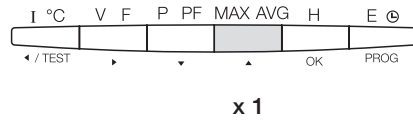

(FR) Hystérésis de la sortie relais N° 1
 Exemple : HYST = 20 %

(DE) Hysterese des Relaisausgangs Nr. 1
 Beispiel: HYST = 20 %

(GB) N° 1 output relay hysteresis
 Example : HYST = 20 %

(IT) Isteresi dell' uscita relè n° 1
 Esempio: HYST = 20 %

(NL) Hysterese van de relaisuitgang n° 1
 Voorbeeld: HYST = 20 %

(ES) Histéresis de la salida relé n° 1
 Ejemplo: HYST = 20 %

(PT) Histeresia da saída relés n° 1
 Exemplo: HYST = 20 %

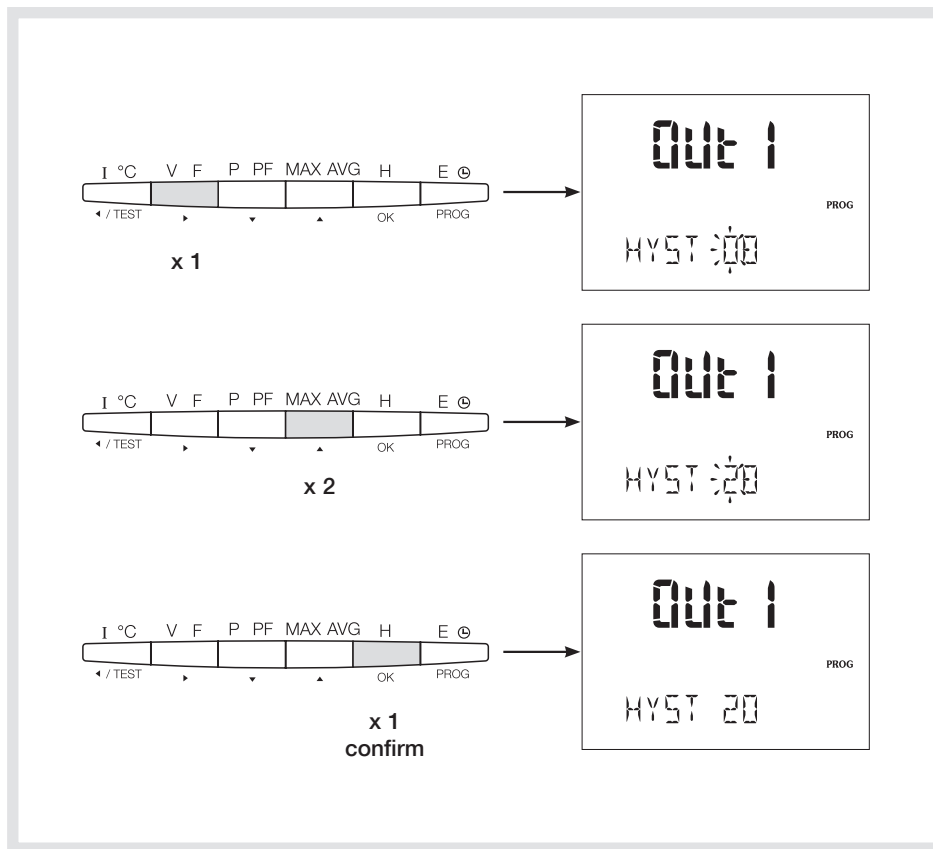

Programmation - Konfiguration - Programming - Programmazione - Programmering- Programación - Programação

- (FR)** Temporisation de la sortie relais N° 1
 Exemple : TEMPO = 30 s
- (DE)** Verzögerungszeit des Relaisausgangs Nr. 1
 Beispiel: TEMPO = 30 s
- (GB)** N° 1 output relay time delay
 Example : TEMPO = 30 s
- (IT)** Temporizzazione dell' uscita relè n° 1
 Esempio: TEMPO = 30 s
- (NL)** Wachtijd van de relaisuitgang n° 1
 Voorbeeld: TEMPO = 30 s
- (ES)** Temporización de la salida relé n° 1
 Ejemplo: TEMPO = 30 s
- (PT)** Temporização da saída relés n° 1
 Exemplo: TEMPO = 30 s

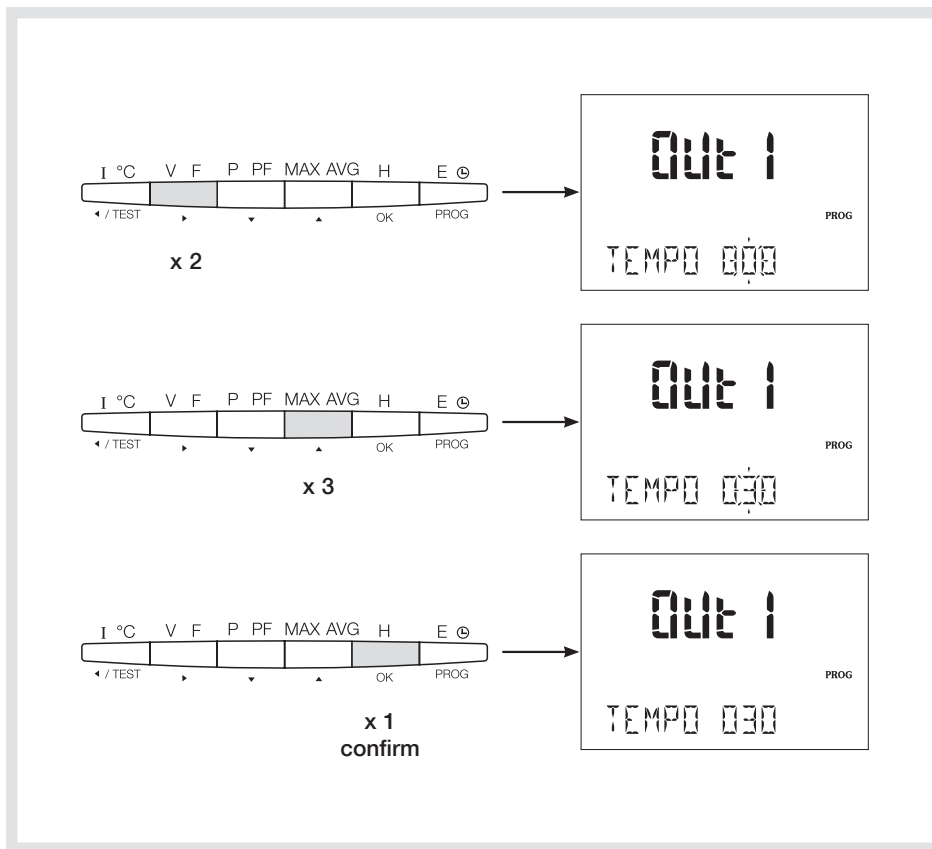

Programmation - Konfiguration - Programming - Programmazione - Programmering- Programación - Programação

- Ⓡ **Mode de travail de la sortie relais N° 1**
Exemple : RELAY = NC
- Ⓡ **Betriebsmodus des Relaisausgangs Nr. 1**
Beispiel: RELAY = NC
- Ⓡ **N° 1 output relay run mode**
Example : RELAY = NC
- Ⓡ **Modo di lavoro dell' uscita relè N° 1**
Esempio: RELAY = NC
- Ⓡ **Werkmodus van de relaisuitgang N° 1**
Voorbeeld: RELAY = NC
- Ⓡ **Modo de trabajo de la salida relé N° 1**
Ejemplo: RELAY = NC
- Ⓡ **Modo de trabalho da saída relés N° 1**
Exemplo: RELAY = NC

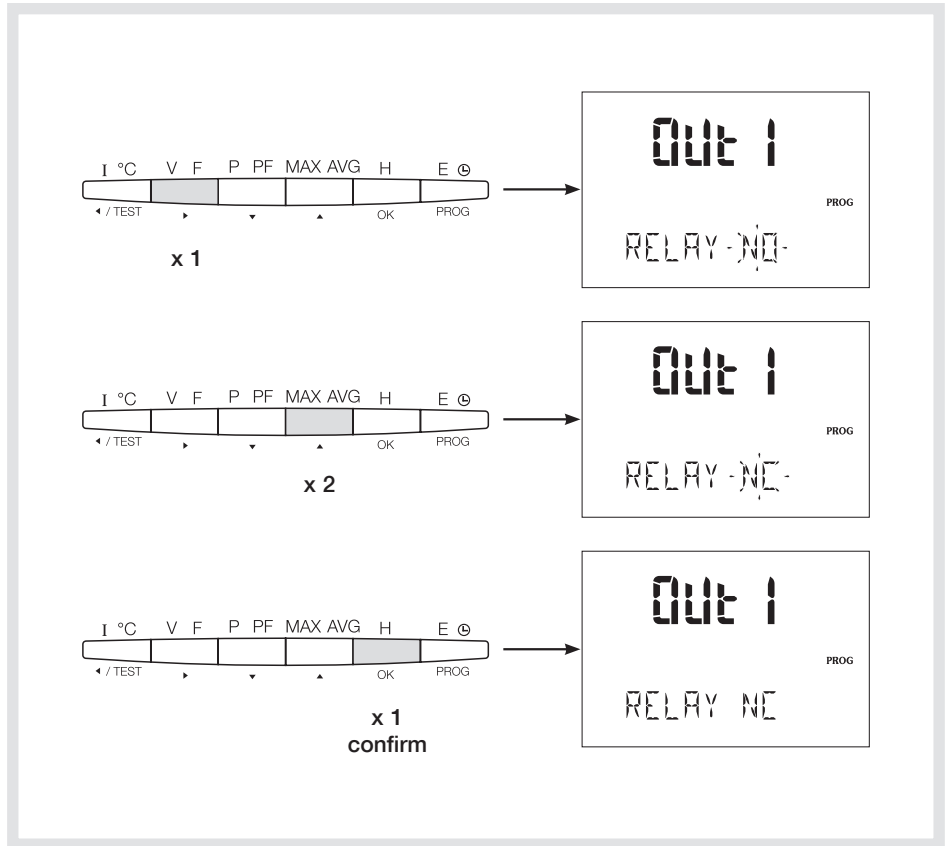

- (FR) **Programmation des sorties relais**
N° 2 - 3 - 4 - 5 - 6
Procédez comme pour la sortie
relais numéro 1
- (DE) **Programmierung der Relaisausgänge**
Nr. 2 - 3 - 4 - 5 - 6
Wie beim Relaisausgang Nummer 1
beschrieben durchführen
- (GB) **Programming relay outputs**
N°s 2 - 3 - 4 - 5 - 6
Proceed as for number 1 relay output
- (IT) **Programmazione delle uscite relé**
N° 2 - 3 - 4 - 5 - 6
Procedere come per l'uscita relé numero 1
- (NL) **Programmatie van de relaisuitgangen**
Nr 2 - 3 - 4 - 5 - 6
Ga te werk als voor de relaisuitgang
nummer 1
- (ES) **Programación de la salida relé**
N° 2 - 3 - 4 - 5 - 6
Proceda de la misma manera que para
la salida relé número 1
- (PT) **Programação da saída relés**
N° 2 - 3 - 4 - 5 - 6
Proceda como para a saída relés
número 1

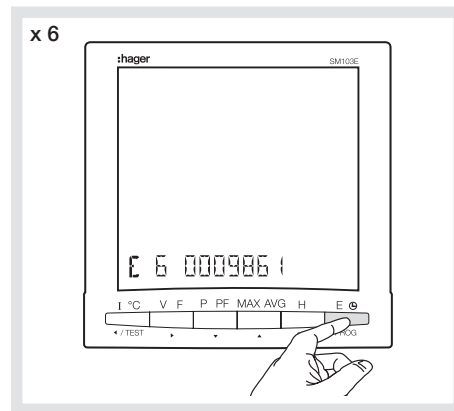
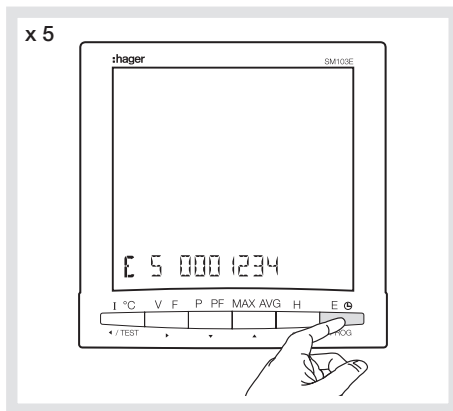
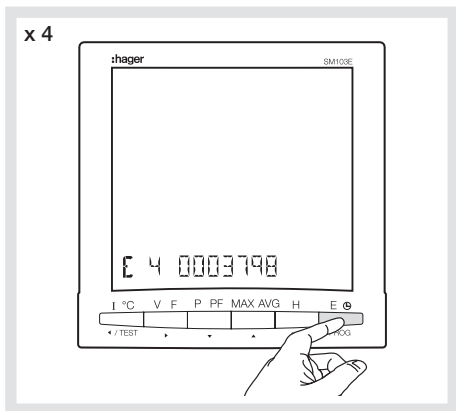
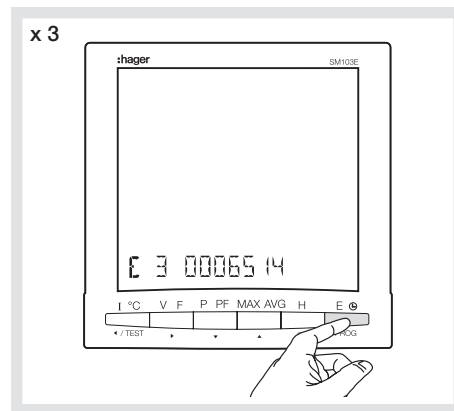
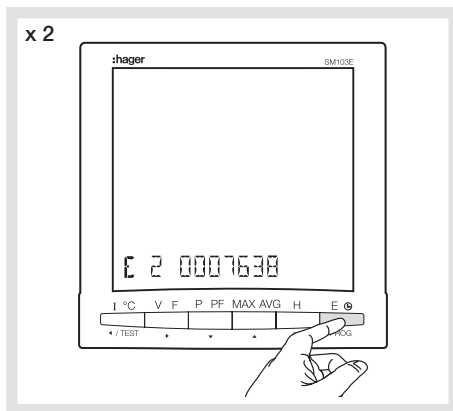
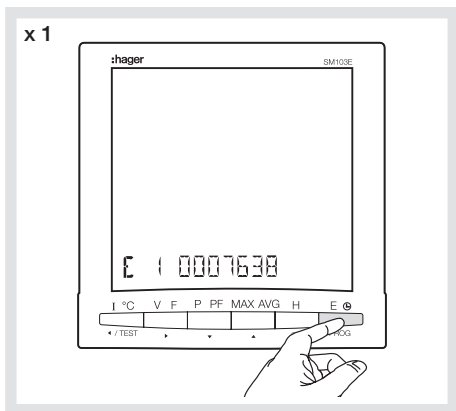

FR

SORTIES RELAIS

Relais max.	μ 230VAC - 5A MAX - AC1
Nombre de manœuvres	$\leq 10^5$
Isolation galvanique	2,5 kV
Temps de réponse	1s
ENTRÉES OPTOCOUPLEURS	
Tension directe max.	30 V DC
Tension directe min.	10 V DC
Tension inverse max.	30 V DC
Isolation galvanique	3 kV
Durée minimum de l'impulsion	10 ms
Nombre max de manœuvres	10^8

GB

RELAY OUTPUTS

Relay max.	μ 230VAC - 5A MAX - AC1
N° of operations	$\leq 10^5$
Galvanic insulation	2.5 kV
Response time	1s
OPTOCOUPLER INPUTS	
Max. direct voltage	30 V DC
Min. direct voltage	10 V DC
Max. inverse voltage	30 V DC
Galvanic insulation	3 kV
Min. pulse duration	10 ms
Max number of operations	10^8

DE

RELAISAUSGÄNGE

Relais max.	μ 230VAC - 5A MAX - AC1
Anzahl der Schaltspiele	$\leq 10^5$
Galvanische Trennung	2,5 kV
Reaktionszeit 1s	1s
OPTOKOPLEREINGÄNGE	
Maximale Vorwärtsspannung	30 V DC
Minimale Vorwärtsspannung	10 V DC
Maximale Sperrspannung	30 V DC
Galvanische Trennung	3 kV
Minimale Impulsdauer	10 ms
Maximale Anzahl der Betätigungen	10^8

IT

USCITE RELÈ

Relè	μ 230VAC - 5A MAX - AC1
Numero di operazioni	$\leq 10^5$
Isolamento galvanico	2,5 kV
Tempo di risposta	1s
ENTRATE OTTOCOMBINATRICI	
Tensione diretta max.	30 V DC
Tensione diretta min.	10 V DC
Tensione inversa max.	30 V DC
Isolamento galvanico	3 kV
Durata minima dell' impulso	10 ms
Numero max di operazioni	10^8

NL

RELAISUITGANGEN

Relais	μ 230VAC - 5A MAX - AC1
Aantal handelingen	$\leq 10^5$
Galvanische isolatie	2,5 kV
Antwoordtijd	1s
INGANGEN OPTOKOPPELAARS	
Max. directe spanning	30 V DC
Min. directe spanning	10 V DC
Max. omgekeerde spanning	30 V DC
Galvanische isolatie	3 kV
Minimale impulsduur	10 ms
Aantal handelingen	10^8

PT

SAÍDAS RELÉS

Relés	μ 230VAC - 5A MAX - AC1
Número de manobras	$\leq 10^5$
Isolamento galvánico	2,5 kV
Tempo de resposta	1s
ENTRADAS OPTOACOPLADORES	
Tensão directa máxima	30 V DC
Tensão directa mínima	10 V DC
Tensão contrária máxima	30 V DC
Isolamento galvánico	3 kV
Duração mínima da impulsão	10 ms
Número máximo de manobras	10^8

ES

SALIDAS RELÉ

Relé	μ 230VAC - 5A MAX - AC1
Número de maniobras	$\leq 10^5$
Aislamiento galvánico	2,5 kV
Tiempo de respuesta	1s
ENTRADAS OPTOACOPLADORES	
Tensión directa máxima	30 V DC
Tensión directa mínima	10 V DC
Tensión inversa máxima	30 V DC
Aislamiento galvánico	3 kV
Duración mínima de la impulsión	10 ms
Número máximo de maniobras	10^8

Lexique des abréviations - Glossar der Abkürzungen - Glossary of abbreviations -
 Elenco delle abbreviazioni - Lijst van afkortingen - Léxico de las abreviaciones - Léxico das abreviaturas



/	Unité affiché sur l'afficheur (ex : / A = Ampères)
$\Sigma P+$	Puissance active positive totale
$\Sigma P-$	Puissance active négative totale
$\Sigma Q+$	Puissance réactive positive totale
$\Sigma Q-$	Puissance réactive négative totale
ΣS	Puissance apparente totale
ΣPFL	Facteur de puissance inductif
ΣPFC	Facteur de puissance capacitif
CDE	Commande de l'état du relais via la RS 485
CD-t	Commande de l'état du relais via la RS485 avec retour à l'état de repos au bout de 1 à 999 secondes en fonction de la temporisation programmée
F	Fréquence
HOUr	Compteur horaire
I	Courant I1, I2, I3
In	Courant de neutre
In1 ... In2	Entrées optocoupleurs 1 à 6
K	Kilo (ex : kA = kilo ampères)
M	Méga (ex : MA = méga ampères)
NC	Relais normalement ouvert
NO	Relais normalement fermé
Out 1 A-Cd... Out 6 A-Cd	Sorties relais N°1 à 6
Out 1 Ht... Out 6 Ht	Seuil haut de l'alarme
Out 1 HYST ... Out 6 HYST	Hystérésis de 0 à 99 %
Out 1 Lt ... Out 6 Lt	Seuil bas de l'alarme
Out 1 RELAY ... Out 6 RELAY	Etat au repos de la sortie relais
Out 1 TEMPO ... Out 6 TEMPO	Temporisation à l'enclenchement du relais de 0 à 999 s.

PPR	Puissance active totale prédictive
QPR	Puissance réactive totale prédictive
SPR	Puissance apparente totale prédictive
T°C1	Température sonde externe 1
T°C2	Température sonde externe 2
T°C3	Température sonde externe 3
T°C4	Température sonde interne 4
THD I	Taux de distorsion harmonique courant sur les phases
THD In	Taux de distorsion harmonique courant sur le neutre
THD U	Taux de distorsion harmonique tension composée
THD V	Taux de distorsion harmonique tension simple
TYPE	Affectation des relais de sortie
U	Tensions composées U12, U23, U31
V	Tensions simples V1, V2, V3

Lexique des abréviations - Glossar der Abkürzungen - Glossary of abbreviations -
 Elenco delle abbreviazioni - Lijst van afkortingen - Léxico de las abreviaciones - Léxico das abreviaturas

DE

/	Angezeigte Einheit auf dem Display (z.B /A= Ampere)
$\Sigma P+$	Summe positive Wirkleistung
$\Sigma P-$	Summe negative Wirkleistung
$\Sigma Q+$	Summe positive Blindleistung
$\Sigma Q-$	Summe negative Blindleistung
ΣS	Summe Scheinleistung
ΣPFL	Induktiver Leistungsfaktor
ΣPFC	Kapazitiver Leistungsfaktor
CDE	Steuerung des Relaiszustandes über RS485
CD-t	Steuerung des Relaiszustandes über RS485 mit Rückkehr zum Ruhezustand
F	Frequenz
HOUr	Betriebsstundenzähler
I	Strom I1, I2, I3
In	Neutralleiterstrom
In1 ... In 2	Eingang Oktokopler 1 bis 6
K	Kilo (z.B: kA = Kilo Ampere)
M	Mega (z.B : MA = Mega Ampere)
NC	Öffnerkontakt
NO	Schliesserkontakt
Out 1 A-Cd... Out 6 A-Cd	Relaisausgänge Nr. 1 bis 6
Out 1 Ht...Out 6 Ht	Oberer Schwellwert des Alarmes
Out 1 HYST ... Out 6 HYST	Hysterese von 0 bis 99%
Out 1 Lt ... Out 6 Lt	Unterer Schwellwert des Alarmes
Out 1 RELAY ... Out 6 RELAY	Ruhezustand des Ausgangsrelais
Out 1 TEMPO ... Out 6 TEMPO	Verzögerung bei Einschaltung des Relais von 0 bis 999 S.
PPR	Prädiktive Gesamt-Wirkleistung
QPR	Prädiktive Gesamt-Blindleistung

SPR	Prädiktive Gesamt-Scheinleistung
T°C1	Temperatur externe Sonde 1
T°C2	Temperatur externe Sonde 2
T°C3	Temperatur externe Sonde 3
T°C4	Temperatur interne Sonde 4
THD I	Klirrfaktor der harmonischen Oberwellen des Stromes auf den Aussenleitern
THD In	Klirrfaktor der harmonischen Oberwellen des Stromes auf dem Neutralleiter
THD U	Klirrfaktor der harmonischen Oberwellen der verketteten Spannung
THD V	Klirrfaktor der harmonischen Oberwellen der einfachen Spannung
TYPE	Zuweisung des Ausgangsrelais
U	Verkettete Spannungen U12, U23, U31
V	Spannung V1,V2,V3

Lexique des abréviations - Glossar der Abkürzungen - Glossary of abbreviations -
 Elenco delle abbreviazioni - Lijst van afkortingen - Léxico de las abreviaciones - Léxico das abreviaturas



/	Value displayed (e.g. : A = Amps)
ΣP+	Total positive active power
ΣP-	Total negative active power
ΣQ+	Total positive reactive power
ΣQ-	Total negative reactive power
ΣS	Total effective power
ΣPFL	Power factor (lagging)
ΣPFC	Power factor (leading)
CDE	Relay status control via RS 485
CD-t	Relay status control via RS 485 with return to unenergised state
F	Frequency
HOUr	Hour meter
I	Current I1, I2, I3
In	Neutral current
In1 ... In2	Optocoupler inputs 1 to 6
K	Kilo (e.g. : kA = kilo amps)
M	Mega (e.g. : MA = mega amps)
NC	Relay normally off
NO	Relay normally on
Out 1 A-Cd... Out 6 A-Cd	Relay outputs 1 to 6
Out 1 Lt ... Out 6 Lt	Alarm lower threshold
Out 1 Ht...Out 6 Ht	Alarm upper threshold
Out 1 HYST ... Out 6 HYST	Hysteresis from 0 to 99%
Out 1 RELAY ... Out 6 RELAY	Unenergised output relay
Out 1 TEMPO ... Out 6 TEMPO	Relay switching time delay from 0 to 999 s.
PPR	Predicted total active power
QPR	Predicted total reactive power
SPR	Predicted total apparent power
T°C1	External sensor temperature 1
T°C2	External sensor temperature 2

T°C3	External sensor temperature 3
T°C4	Internal sensor temperature 4
THD I	Current harmonic distortion (phases)
THD In	Current harmonic distortion (neutral)
THD U	Phase-to-phase harmonic distortion
THD V	Phase-to-neutral harmonic distortion
TYPE	Output relays allocation
U	Phase-to-phase voltage U12, U23, U31
V	Phase-to-neutral voltage V1, V2, V3

Lexique des abréviations - Glossar der Abkürzungen - Glossary of abbreviations -
 Elenco delle abbreviazioni - Lijst van afkortingen - Léxico de las abreviaciones - Léxico das abreviaturas



/	Unità di misura (es. / A = Ampère)
ΣP+	Potenza attiva positiva di sistema
ΣP-	Potenza attiva negativa di sistema
ΣQ+	Potenza reattiva positiva di sistema
ΣQ-	Potenza reattiva negativa di sistema
ΣS	Potenza apparente di sistema
ΣPFL	Fattore di potenza induttivo
ΣPFC	Fattore di potenza capacitivo
CDE	Comando dello stato dei relé tramite RS485
CD-t	Comando dello stato dei relé tramite RS485 con ritorno nello stato di riposo
F	Frequenza
HOUr	Contatore orario
I	Correnti I1, I2, I3
In	Corrente di neutro
In1 ... In2	Ingressi digitali da 1 a 6
K	kilo (es. / kA = kilo Ampère)
M	Mega (es. / MA = Mega Ampère)
NC	Relé normalmente aperto
NO	Relé normalmente chiuso
Out 1 A-Cd... Out 6 A-Cd	Uscite relé da 1 a 6
Out 1 Ht...Out 6 Ht	Soglia massima di allarme
Out 1 Lt ... Out 6 Lt	Soglia minima di allarme
Out 1 HYST ... Out 6 HYST	Isteresi da 0 a 99%
Out 1 TEMPO ... Out 6 TEMPO	Ritardo da 0 a 999 sec.
Out 1 RELAY ... Out 6 RELAY	Stato di riposo del relé
PPR	Potenza attiva totale predittiva
QPR	Potenza reattiva totale predittiva

SPR	Potenza apparente totale predittiva
T°C1	Temperatura sonda esterna 1
T°C2	Temperatura sonda esterna 2
T°C3	Temperatura sonda esterna 3
T°C4	Temperatura sonda interna 4
THD I	THD% delle correnti di fase
THD In	THD% della corrente di neutro
THD U	THD% delle tensioni concatenate
THD V	THD% delle tensioni di fase
TYPE	Impostazione dei relé d'uscita
U	Tensioni concatenate U12, U23, U31
V	Tensioni di fase V1, V2, V3

Lexique des abréviations - Glossar der Abkürzungen - Glossary of abbreviations -
 Elenco delle abbreviazioni - Lijst van afkortingen - Léxico de las abreviaciones - Léxico das abreviaturas

Z

/ display	Weergegeven eenheid op (bv. / A = Ampère)
$\Sigma P+$	Totaal actief positief vermogen
$\Sigma P-$	Totaal actief negatief vermogen
$\Sigma Q+$	Totaal reactief positief vermogen
$\Sigma Q-$	Totaal reactief negatief vermogen
ΣS	Totaal schijnbaar vermogen
ΣPFL	Inductieve vermogensfactor
ΣPFC	Capacitatieve vermogensfactor
CDE	Bediening van het relais via RS 485
CD-t	Bediening van het relais via RS485 met terugkeer naar rust- toestand
F	Frequentie
HOUr	Uurteller
I	Stroom I1, I2, I3
In	Stroom neuter
In1 ... In 2	Ingangen opto-koppelingen 1 tot 6
K	Kilo (bv. kA = kilo-ampères)
M	Mega (bv. MA = mega-ampères)
NC	Relais normaal open
NO	Relais normaal gesloten
Out 1 A-Cd... Out 6 A-Cd	Relaisuitgangen Nr. 1 tot 6
Out 1 Ht... Out 6 Ht	Alarmdrempel boven
Out 1 HYST ... Out 6 HYST	Hysterese van 0 tot 99%
Out 1 Lt ... Out 6 Lt	Alarmdrempel onder
Out 1 TEMPO ... Out 6 TEMPO	Temporisatie bij inschakeling relais van 0 tot 999 s.
Out 1 RELAY ... Out 6 RELAY	Toestand bij rust uitgang relais

PPR	Voorspelbaar totaal actief vermogen
QPR	Voorspelbaar totaal reactief vermogen
SPR	Voorspelbaar totaal schijnbaar vermogen
T°C1	Temperatuur externe sensor
T°C2	Temperatuur externe sensor
T°C3	Temperatuur externe sensor
T°C4	Temperatuur interne sensor
THD I	Harmonische vervormingsfactor stroom op de fasen
THD In	Harmonische vervormingsfactor stroom op de neuter
THD U	Harmonische vervormingsfactor samengestelde spanning
THD V	Harmonische vervormingsfactor enkelvoudige spanning
TYPE	Toewijzing van de uitgangsrelais
U	Samengestelde spanningen U12, U23, U31
V	Enkelvoudige spanningen V1, V2, V3

Lexique des abréviations - Glossar der Abkürzungen - Glossary of abbreviations -
 Elenco delle abbreviazioni - Lijst van afkortingen - Léxico de las abreviaciones - Léxico das abreviaturas

ES

/	Unidad visualizada en el display (ej.: / A = Amperios)
ΣP+	Potencia activa positiva total
ΣP-	Potencia activa negativa total
ΣQ+	Potencia reactiva positiva total
ΣQ-	Potencia reactiva negativa total
ΣS	Potencia aparente total
ΣPFL	Factor de potencia inductivo
ΣPFC	Factor de potencia capacitivo
CDE	Mando del estado del relé a través del Bus RS-485
CD-t	Mando del estado del relé a través del Bus RS-485 con regreso al estado de reposo
F	Frecuencia
HOUr	Contador horario
I	Intensidad I1, I2, I3
In	Intensidad del neutro
In1 ... In 2	Entradas optocopladas 1 a 6
K	Kilo (ej.: kA = kiloamperios)
M	Mega (ej.: MA = megaamperios)
NC	Relé normalmente abierto
NO	Relé normalmente cerrado
Out 1 A-Cd... Out 6 A-Cd	Salidas de relés N°1 a 6
Out 1 Ht...Out 6 Ht	Umbral alto de alarma
Out 1 Lt ... Out 6 Lt	Umbral bajo de alarma
Out 1 HYST ... Out 6 HYST	Histeresis de 0 a 99%
Out 1 TEMPO ... Out 6 TEMPO de 0 a 999 s.	Temporización al cierre del relé
Out 1 RELAY ... Out 6 RELAY	Estado de reposo de la salida relés
PPR	Potencia activa total predictiva
QPR	Potencia reactiva total predictiva

SPR	Potencia aparente total predictiva
T°C1	Temperatura de la sonda externa 1
T°C2	Temperatura de la sonda externa 2
T°C3	Temperatura de la sonda externa 3
T°C4	Temperatura de la sonda interna 4
THD I	Grado de distorsión armónico (thd) intensidad sobre las fases
THD In	Grado de distorsión armónico (thd) intensidad sobre el neutro
THD U	Grado de distorsión armónico (thd) tensión compuesta
THD V	Grado de distorsión armónico (thd) tensión simple
TYPE	Asignación de los relés de salida
U	Tensiones compuestas U12, U23, U31
V	Tensiones simples V1, V2, V3

Lexique des abréviations - Glossar der Abkürzungen - Glossary of abbreviations -
 Elenco delle abbreviazioni - Lijst van afkortingen - Léxico de las abreviaciones - Léxico das abreviaturas

PT

/	Unidade visualizada no mostrador (ex. / A = Amperes)
$\Sigma P+$	Potência activa positiva total
$\Sigma P-$	Potência activa negativa total
$\Sigma Q+$	Potência reactiva positiva total
$\Sigma Q-$	Potência reactiva negativa total
ΣS	Potência aparente total
ΣPFL	Factor de potência indutivo
ΣPFC	Factor de potência capacitivo
CDE	Comando do estado do relé via RS 485
CD-t	Comando do estado do relé via RS485 com retorno à etapa de repouso
F	Frequência
HOUr	Contador horário
I	Corrente I1, I2, I3
In	Corrente de neutro
In1 ... In2	Entradas optoacopladores 1 a 6
K	Kilo (ex. kA = quiloamperes)
M	Mega (ex. MA = megamperes)
NC	Relé normalmente aberto
NO	Relé normalmente fechado
Out 1 A-Cd... Out 6 A-Cd	Saídas relés N°1 a 6
Out 1 Ht...Out 6 Ht	Limiar superior do alarme
Out 1 HYST ... Out 6 HYST	Histerese de 0 a 99%
Out 1 Lt ... Out 6 Lt	Limiar inferior do alarme
Out 1 RELAY ... Out 6 RELAY	Estado em repouso da saída relé
Out 1 TEMPO ... Out 6 TEMPO	Temporização no armar do relé de 0 a 999 s.
PPR	Potência activa total preditiva
QPR	Potência reactiva total preditiva

SPR	Potência aparente total preditiva
T°C1	Temperatura da sonda externa 1
T°C2	Temperatura da sonda externa 2
T°C3	Temperatura da sonda externa 3
T°C4	Temperatura da sonda interna 4
THD I	Grau de distorção harmónica corrente nas fases
THD In	Grau de distorção harmónica corrente no neutro
THD U	Grau de distorção harmónica tensão composta
THD V	Grau de distorção harmónica tensão simples
TYPE	Atribuição dos relés de saída
U	Tensões compostas U12, U23, U31
V	Tensões simples V1, V2, V3

Hager SAS
132 Boulevard d'Europe
BP 78
F-67212 OBERNAI CEDEX
www.hager.fr

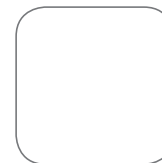
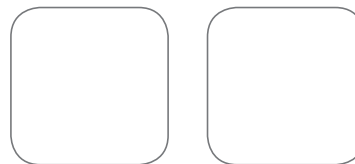

538029B